

Ordering Guide

for BUDI-S and BUDI-M product range



Ordering Guide of the building distribution enclosure BUDI-S and BUDI-M product line

This document provides assistance with the selection of racks for use in FIST applications. It includes the following sections:

1 Product description

2 Ordering information

2.1 BUDI FTTH Termination version

2.2 BUDI FIST Splice version

2.3 BUDI FIST Splice/Patch version

3 General accessories

3.1 Cable seals and cable termination blocks

3.2 Glands

1 Product description

The BUDI Wall Boxes provide one or more of the following features or functions: management, storage, organization and re-arrangement of optical fibers, connectors, adapters, patchcords, cables, optical components and other network components; the facility to locate and integrate the functions of (passive) optical components, i.e. splicing, splitting and ribbon fan-out. In this BUDI Patch wall box, all passive optical components such as splitters are supplied in a pre-terminated and protective housing (OCM6) to allow customers to be connected with a simple patch operation.

–

The BUDI wall boxes are designed to operate in category C (controlled), category G (outdoor ground level) and category A (aerial) as characterized by IEC 61753-1. This covers both indoor and outdoor applications. In the former case this would typically be on the customer's premises such as building basements, telecommunications equipment rooms, computer rooms, etc. Non-protected locations include pole mountings and external wall sites.

The BUDI wall box consists of a bottom part and a cover, with a profiled seal for environmental protection. The protection level against water and dust is IP55.

The enclosure is UL listed, UV stable and is made from LSZH plastics.

The outgoing fibers are terminated in splice-patch trays to allow the fiber ends to be spliced to pigtails (connectors) or to store the overlength of the pre-terminated riser cable fibers.

A base tray is provided to allow the incoming fibers to be spliced to pigtails to allow later the insertion of the splitter modules (PON FTTH applications) in a frame to make a direct connection between the feeding pigtail and the input connection of the splitter by a simple insert-and-connect operation. The unused splitter ports can be parked in a waiting-position (parking panel integrated in the cover of the top patch tray) to be used when an additional customer takes service.

Customers are connected by patching one of the parked connectors in one of the adapters, mounted in one of the patch trays, connected to the fiber of the selected customer.

The base tray allows as well connecting up to 8 direct links between the feeder cable and a drop cable to connect some business customers in a point-to-point method. This is typically used to connect business customers separated from the residential customers linked to the same access network.

The box allows easy fiber access during installation, maintenance, and addition of fiber management modules.

The BUDI wall box shall be capable of accommodating the fibers of an uncut looped optical fiber cable.

It shall be possible to terminate different cable types and constructions.

All fiber cable elements shall be routed in such a way that no transmission degradation is seen when accessing these cable elements. The minimum bend radius of the fibers shall be 30 mm throughout the whole organizer system.

There are multiple wrap around cable seals available. This serves either for cable loop-through, or for in- and out-going cables.

Depending on the drop cable construction several drop cables can be installed in the box also with push through ports. Central strength member reinforced cables shall be fixed to the box with a strength member connection. A sealing mechanism is provided to seal the cable ports (standard cable glands PG 16, 21 and 29 or cold sealing components).

Minimum 2 sealed outlet ports shall be available for pigtails. It is easily re-enterable to add extra pigtail cords without disturbing existing circuits.

Two sizes are available to accommodate 24 and 48 SC connectors or 48 and 96 terminations using LC connectors.

On request the boxes shall be lockable with a key.

For customers that want to use this enclosure for splicing only, the FIST splicing system is integrated using SOSA's to store and manage splices and FSASA splitter modules for accommodating splitters.

1.1 Dimensions

The enclosure exists in two dimensions: BUDI-S and BUDI-M

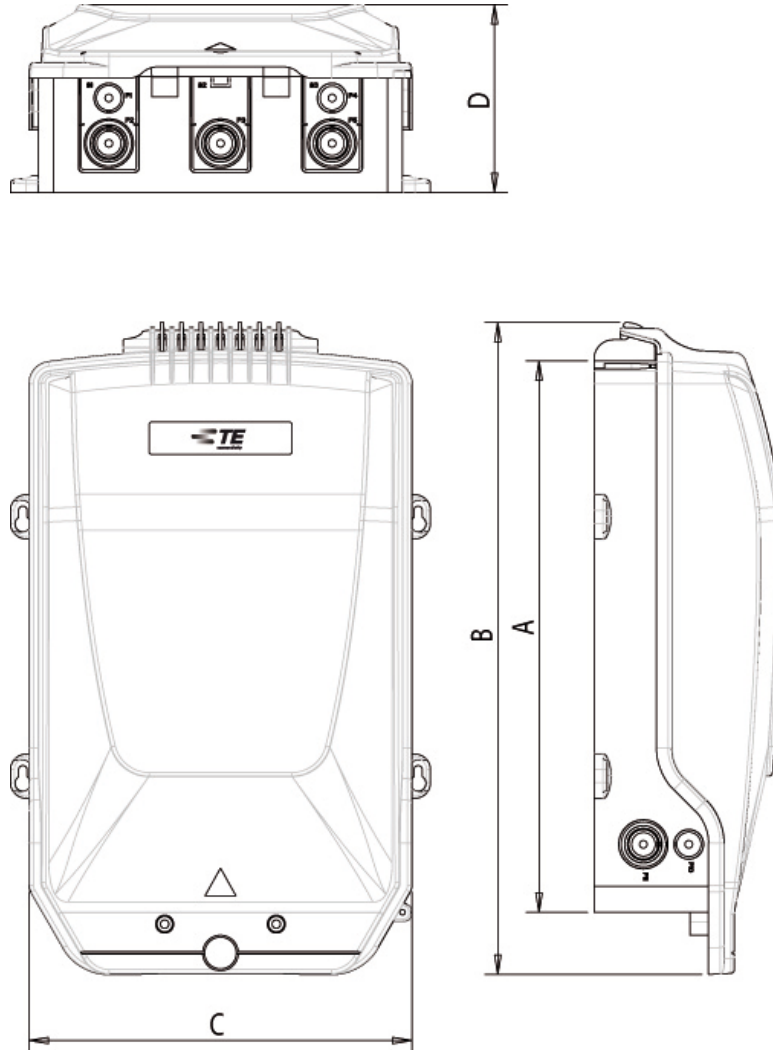

Size	BUDI-M	BUDI-S
A: Height box (mm)	480	425
B: Height cover (mm)	550	500
C: Width (mm)	360	295
D: Depth (mm)	175	145

2 Ordering information

2.1 BUDI FTTH Termination version

The Termination version of the BUDI product range intends to allow patching for both PON (including splitter module OCM6) and PtP architectures in FTTH deployments. The termination version allows connecting customers with a simple connector patch operation (Plug-and-Play) with SC or LC connectors.

Capacities

Size	BUDI-M	BUDI-S
Patch capacity SC connector with Basetray	48	24
Patch capacity SC connector w/o Basetray	60	36
Patch capacity LC connector with Basetray	96	48
Patch capacity LC connector w/o Basetray	120	72
Capacity of OCM6 modules	6	4
Capacity to splice input splitter fibers	6	6
Capacity of PtP cables to terminate on Basetray	8	8
Capacity of PtP splices in Basetray	8	8
Loop cable storage capability	yes	no

BUDI - X- XX - X

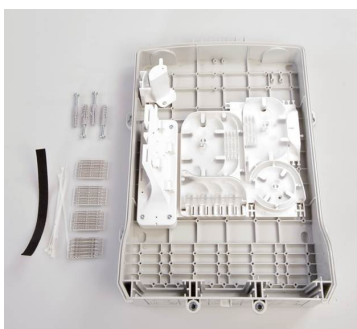
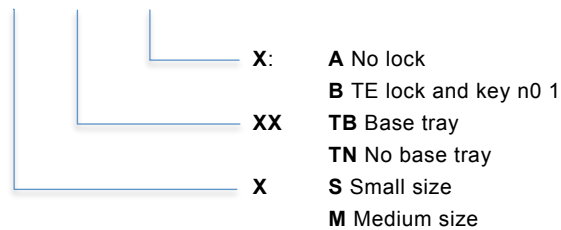

The basic kit contains

- Box base (including closing bolts)
- Box cover (including closing nuts)
- 4 mounting bolts with seals for wall mounting
- Base Tray and covers installed (for TB version only)
- Tray tower for 2 trays installed
- Splitter Pigtail bend control (for TB version only)
- Installation Instruction
- Channeling pins
- Bottom port filled with gland plates

2.1.1 Accessories

To make this box functional, standard application kits were defined that need to be added to the above enclosure.

PON Application Kits for BUDI termination version:

BUDI - PON - 24 SX - X

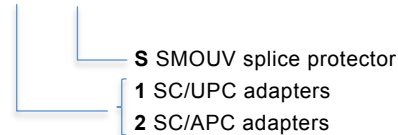

The kit contains

- 2 patch trays (SMOUV splice holder)
- 1 cover
- 1 cover to contain connector parking lots
- 1 OCM6 splitter holder tower for 2 splitter modules
- 1 SC parking array
- 24 S1 (SC/UPC) or S2 (SC/APC) ADK's
- 2 S1 or S2 Adapters for the splitter input connection

BUDI-PON-48-SX-X (BUDI-M only)

The kit contains

- 4 patch trays (SMOUV splice holder)
- 2 patch tray tower extensions
- 3 cover
- 1 cover to contain connector parking lots
- 1 OCM6 splitter holder tower for 2 splitter modules
- 2 splitter holder extensions (for 2 additional OCM6's)
- 2 SC parking arrays
- 1 pigtail management tower
- 48 S1 (SC/UPC) or S2 (SC/APC) ADK's
- 4 S1 or S2 Adapters for the splitter input connection

BUDI-PON-48-LX-X

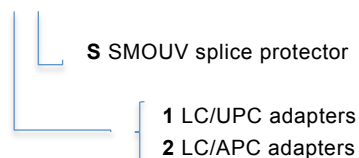

The kit contains

- 2 patch trays (SMOUV splice holder)
- 1 cover
- 1 cover to contain connector parking lots
- 1 OCM6 splitter holder tower for 2 splitter modules
- 2 splitter holder extensions (for 2 additional OCM6's)
- 2 LC parking arrays
- 1 pigtail management tower
- 24 L1 (LC/UPC) or L2 (LC/APC) ADK's (duplex)
- 4 S1 or S2 Adapters for the splitter input connection

BUDI-PON-96-LX-X (BUDI-M only)

The kit contains

- 4 patch trays (SMOUV splice holders)
- 2 patch tray tower extensions
- 3 cover
- 1 cover to contain connector parking lots
- 1 OCM6 splitter holder tower for 2 splitter modules
- 2 splitter holder extensions (for 2 additional OCM6's)
- 2 LC parking arrays
- 1 pigtail management tower
- 48 L1 (LC/UPC) or L2 (LC/APC) ADK's
- 4 S1 or S2 Adapters for the splitter input connection

Tray extension kits

BUDI-TRAY-XX-X-2

Splice holder type

- N:** no splice holders
- A:** ANT splice holder with capacity of 24 splices per tray
- S:** SMOUV with splice holder capacity of 24 splices per tray

Adapter type

- NN:** no ADK's
- S1:** 24 SC/UPC ADK's
- S2:** 24 SC/UAPC ADK's
- L1:** 24 LC/UPC duplex ADK's
- L2:** 24 LC/APC duplex ADK's



The kit contains

- 2 patch trays including splice holder (depending on the selection)
- 2 cover
- 2 tray tower extensions
- ADK's when selected (fully populated)
- cable element fixation accessories
- pigtail management accessories



Splitter Integration OCM6

In-Line OCM6 splitter module

In the connectorized version of the BUDI, the pre-connectorized splitters used are OCM 6 modules that can be inserted with a simple plug and play installation. The connection between the feeding connector and the input connector of the splitter module is made by just inserting the splitter module in the splitter tower.

The input connector is always an SC connector (embedded in the module) and PC or APC as are the outbound connectors selected on the splitter module.

For more details on the OCM6 splitter module, please check its specific data sheet.

For the **BUDI-S** the length of **61 cm** has to be ordered:

OCM6-SXXXXXX-61C1

For example, a 1x8 planar splitter grade P with SC/APC connectors has the description:

OCM6-SP118S2-61C1

For the **BUDI-M** the length of **72 cm** has to be ordered:

OCM6-SXXXXXX-72C1

For example, a 1x8 planar splitter grade P with SC/APC connectors has the description:

OCM6-SP118S2-72C1

Butt OCM6 splitter module

In case one prefers to splice the input fiber to the feeder cable, the input cord is routed to the basetray for splicing.

In this case the following description has to be used:

OCM6-SXXXXXX-61CB1

For example, a 1x16 planar splitter grade P with SC/APC connectors has the description:

OCM6-SP11GS2-61CB1

2.1.2 Other accessories

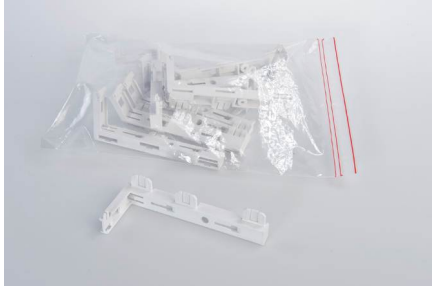

BUDI-SPLITTER-01-(10)

- Splitter holder extension kit with 10OCM6 splitter holders

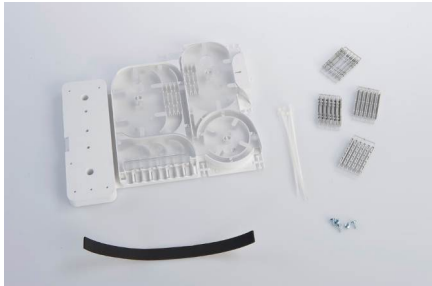

BUDI-BASETRAY-01

- Basetray to splice fibers to pigtails to feed splitters using the universal splice holder including ANT and SMOUV adaptation pieces
- Splice compartment to splice fibers from feeding cable to direct drop cables with splice capacity of 8 splices (universal splice holder)
- Cover for both splice compartments



BUDI-PARKING-SC-(10)

- Kit containing 10 SC connector parking modules for 16 SC connectors



BUDI-PARKING-LC-(10)

- Kit containing 10 LC connector parking modules for 16 connectors

IFDB-KTU

- KTU's to be used in Basetray for the fixation of the direct drops

2.2 BUDI FIST Splice version

BUDI - X- XX - X

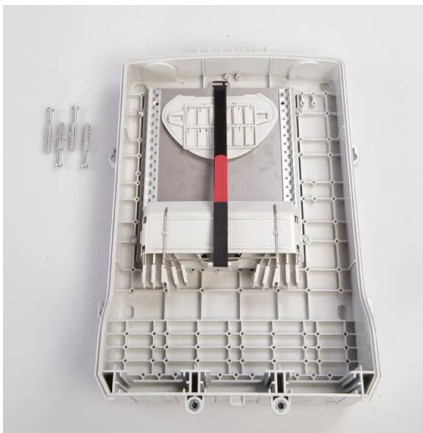
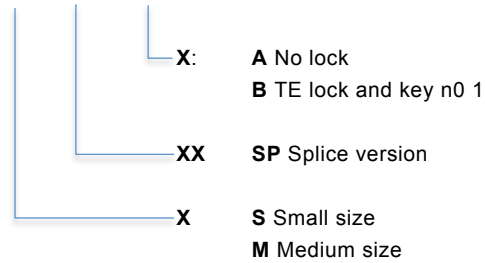

The basic kit contains

- Box base
- The cover
- 4 mounting bolts with seals for wall mounting
- Mounting plate and UMS profile
- FAS routing block and cap including tube holder(s) and retainers
- Tray lid + fiber guiding pin
- Velcro strip
- Tray wedge
- Installation Instruction
- Channeling pins
- Bottom ports filled with gland plates

Size	BUDI-M	BUDI-S
UMS units	36	28
- in combination with flexible cable tubes	40	32
Splice capacity SOSA SC tray (2F/tray)	72	56
Splice capacity SOSA SE tray (12F/tray)	216	168
Loop cable storage capability	yes	yes

2.3 BUDI FIST Splice/Patch version

The Splice/Patch with FIST version of the BUDI product range intends to allow patching for both PON and PtP architectures in FTTH deployments. The termination version allows connecting customers with a simple connector patch operation (Plug-and-Play) with SC or LC connectors in combination with FIST-SOSA2.

Capacities

Size	BUDI-M-TP	BUDI-M-TA	BUDI-S-T
UMS units	24	24	24
Patch capacity SC connector	36	48	24
Patch capacity LC connector	72	72	48
Loop cable storage capability	yes	yes	yes

BUDI - M – XX-X-XX XX XX X X

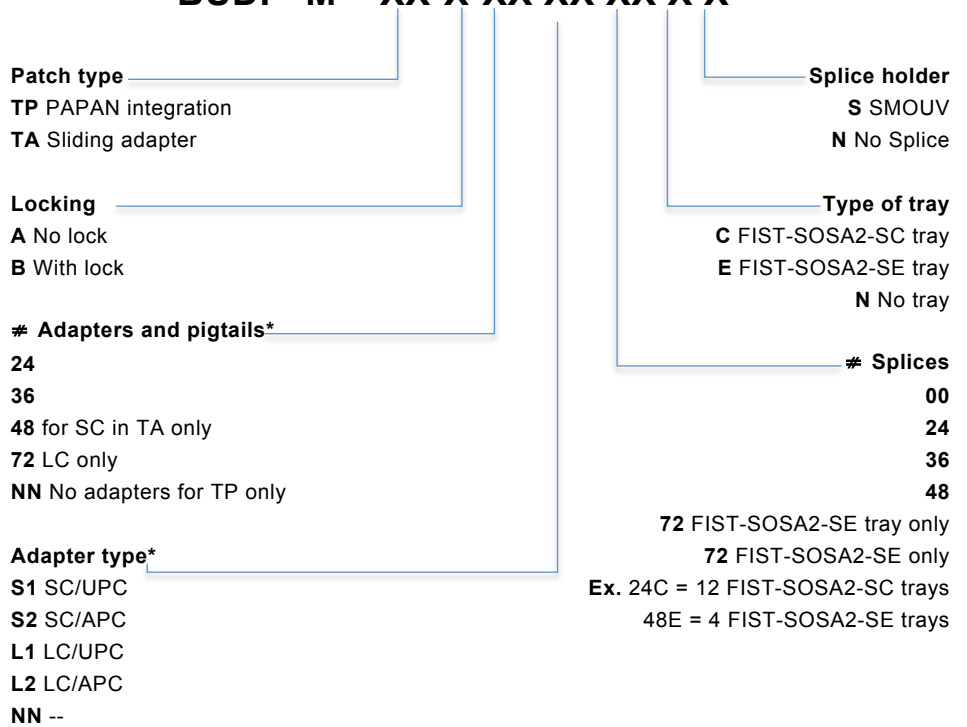

* Pigtails and adapters are included in the packaging but not installed in the product

BUDI - S - T - X-XX-XX XX X X

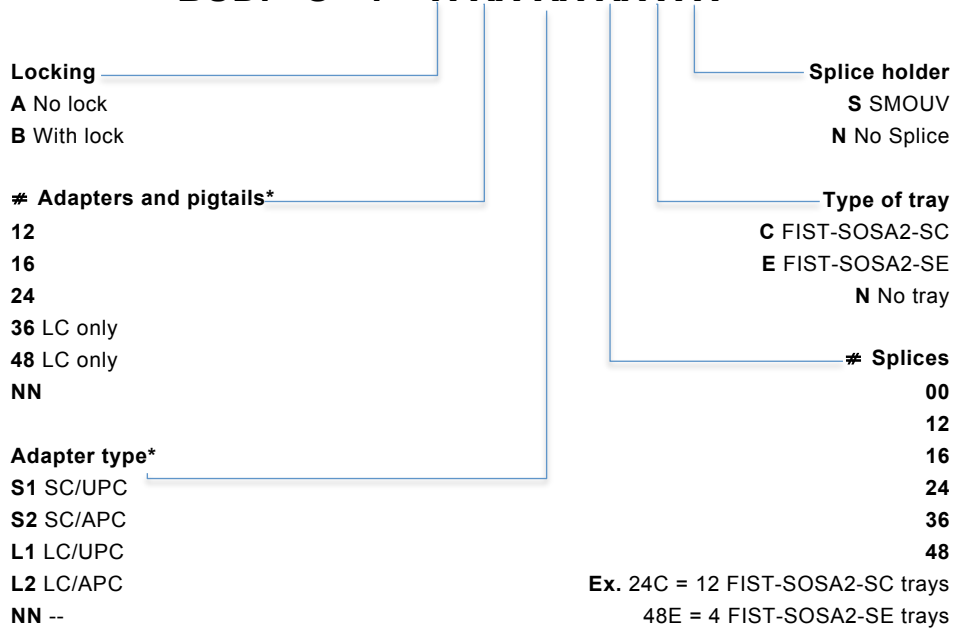

* Pigtails and adapters are included in the packaging but not installed in the product

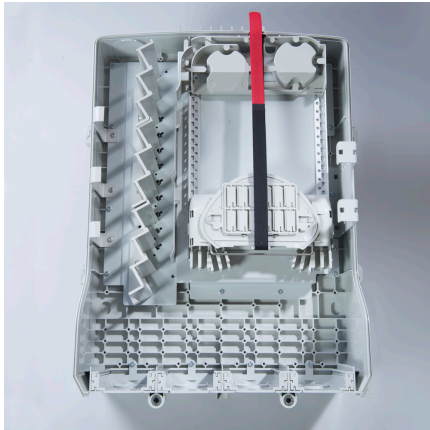

Basic kit content BUDI-M-TP-X

Lock/No lock

- Box base
- Cover
- 4 mounting bolts with wall plugs for wall mounting
- Mounting plate and UMS profile
- FAS block and cap including tube holder(s) and retainers
- Pigtail routing block
- Tray lid
- Tray wedge
- Installation Instruction
- Channeling pins
- PAPAN patch panel
- Loop bracket
- Pigtail retention
- Bottom ports filled with gland plates

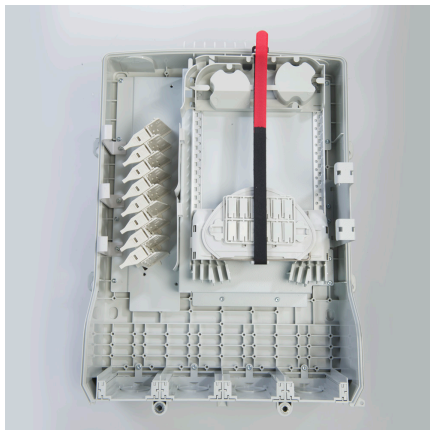

Basic kit content BUDI-M-TA-X

- Box base
- Cover
- 4 mounting bolts with wall plugs for wall mounting
- Mounting plate and UMS profile
- FAS block and cap including tube holder(s) and retainers
- Pigtail routing block
- Tray lid
- Tray wedge
- Installation Instruction
- Channeling pins
- Sliding adapter pack not included, loaded variants as accessory on Data Sheet***
- Loop bracket
- Pigtail retention
- Bottom ports filled with gland plates

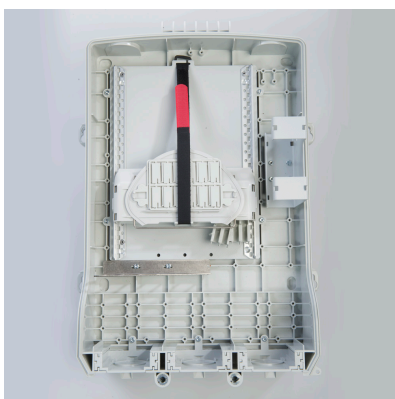

Basic kit content BUDI-S-T-X

- Box base
- Cover
- 4 mounting bolts with wall plugs for wall mounting
- Mounting plate and UMS profile
- FAS block and cap including tube holder(s) and retainers
- Pigtail routing block
- Tray lid
- Tray wedge
- Installation Instruction
- Channeling pins
- Patch panel
- Loop bracket
- Bottom ports filled with gland plates

2.3.1 Accessories

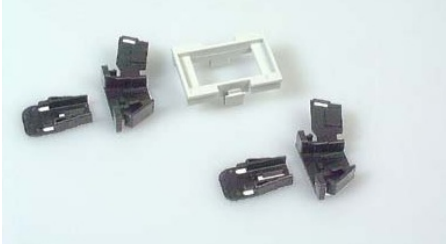

FSA-ADK-H1-4 (BUDI-M-TP and BUDI-S-T version only)

FSA-ADK-H1-4 (BUDI-M-TP version only)

When pigtails are routed out of the box without a patching requirement an aramid strain relief device (KTU) is fitted in the patch panel which can provide strain relief.

Each KTU can accommodate:

- 2 individual pigtails with maximal diameter of 3.1 mm or
- 1 Ribbon4 pigtail or
- 1 Ribbon8 pigtail or
- 1 Ribbon12 pigtail

Maximum 9 retainers (thus 18 KTU's) can be placed in 1 connector patch panel.



FIST-PAPAP-LABEL-(50)

Package of 50 label sheets numbered 1 to 48 to fit the PAPAN patch panel.

Adapters with FIST retainers (BUDI-M-TP and BUDI-M-T versions only)

All information can be found in the datasheet of the optical components section; fiber components; OCA.

3 General accessories

3.1 Cable seals and cable termination blocks

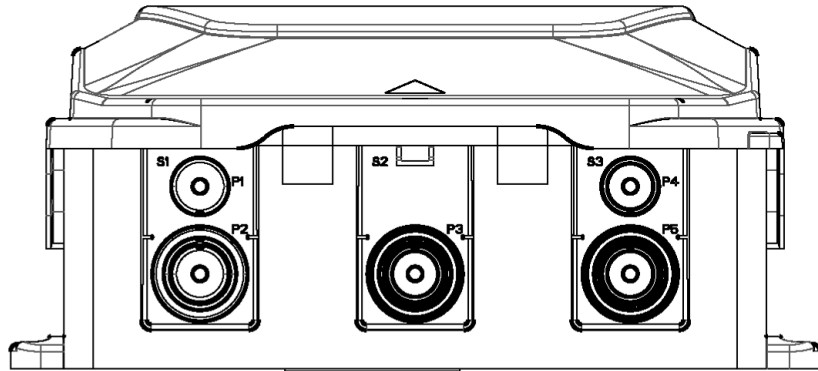

BUDI-S bottom ports

Port number	BUDI-S
S1	All BUDI-S-SEAL kits
S2	All BUDI-S-SEAL kits
S3	All BUDI-S-SEAL kits
P1	PG16
P2	PG16, PG21, PG29
P3	PG16, PG21, PG29
P4	PG16
P5	PG16, PG21, PG29

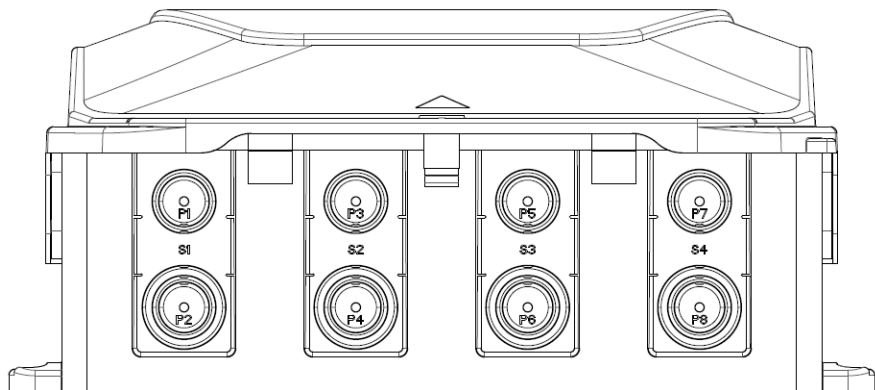

BUDI-M bottom ports

Port number	BUDI-M
S1	All BUDI-M-SEAL kits
S2	All BUDI-M-SEAL kits
S3	All BUDI-M-SEAL kits
P1, P3, P5, P7	PG16, PG21
P2, P4, P6, P8	PG16, PG21, PG29

3.1.1 Seal kits BUDI-S

BUDI-S-SEAL-4x10

Wrap around cable seal for 4 cables up to 10mm diameter including:

- cable fixation bracket and tie wraps
- seal foam tape

On this bracket one can fix the cables as well with ENSTO strength member fixation devices (separate item FIST-SB/MB-STRBR-01) and with hose clamps with an 8mm band.

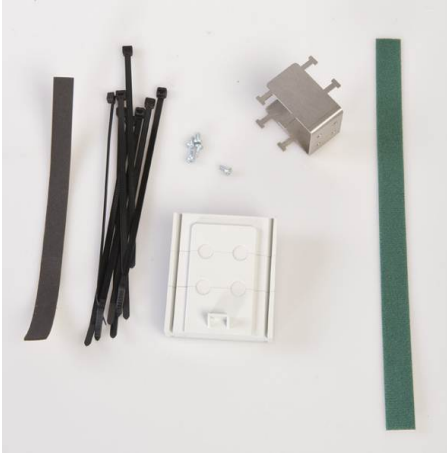

BUDI-S-SEAL-4x15

Wrap around cable seal for 4 cables up to 15mm diameter including:

- cable fixation bracket and tie wraps
- seal foam tape

On this bracket one can fix the cables as well with ENSTO strength member fixation devices (separate item FIST-SB/MB-STRBR-01) and with hose clamps with an 8mm band.



BUDI-S-SEAL-2x20

Wrap around cable seal for 2 cables up to 20mm diameter and cable seal for looped cable installation (for spliced version only of the BUDI-S) including:

- cable fixation bracket, hose clamps and strength member fixation plates
- seal foam tape

On this bracket one can fix the cables as well with ENSTO strength member fixation devices (separate item FIST-SB/MB-STRBR-01) and with hose clamps with an 8mm band.



BUDI-S-SEAL-24x5

Push Through cable seal for 24 cables up to 5mm diameter including:

- cable fixation brackets and tie wraps
- cables can be attached individually

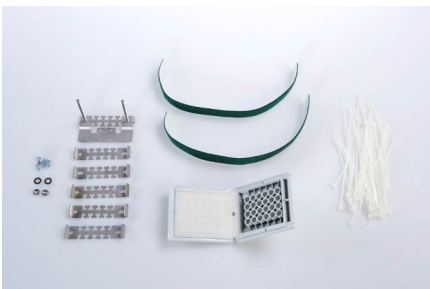

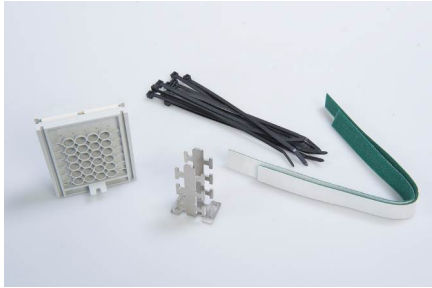
**BUDI-S-SEAL-24x7**

Push Through cable seal for 24 cables up to 7mm diameter including:
cable fixation brackets and tie wraps
cables are attached in groups of 4 cables

**BUDI-S-PTS-48x3**

Wrap around pigtail seal for 48 pigtails with a diameter up to 3.5mm (for **indoor use**)
no cable fixation

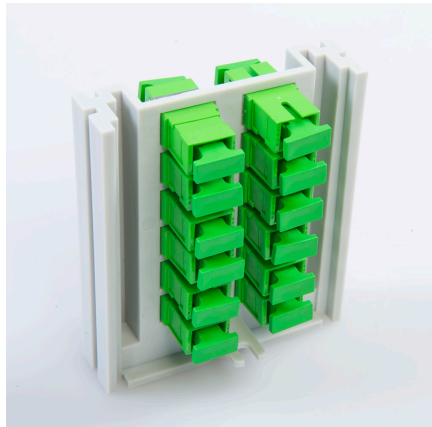
**BUDI-S-PPS-XX XX**

Seal with integrated patch panel up to 24 connections. For indoor use only.

Options:

- BUDI-S-PPS-12 S1 (12 SC/UPC standard C grade according to IEC 61755-1)
- BUDI-S-PPS-12 S2 (12 SC/APC 8° standard C grade according to IEC 61755-1)
- BUDI-S-PPS-24 L1 (24 SC/UPC standard C grade according to IEC 61755-1)
- BUDI-S-PPS-24 L2 (24 SC/APC 8° standard C grade according to IEC 61755-1)

**BUDI-S-LOOPBRCKT-01 (for BUDI-S-SP-X and BUDI-S-T-X)**

Loop bracket to store uncut loose tube overlength in combination with the BUDI-S-SEAL-2x20 cable termination kit.

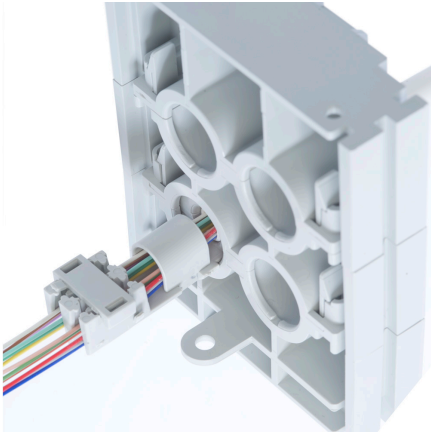

BUDI-S-SEAL-4x15-MINI-N01

Seal + component to clip around the TE Mini-Breakout cable.

3.1.2 Seal kits BUDI-M

BUDI-M-SEAL-6x10

Wrap around cable seal for 6 cables up to 10mm diameter including:

- cable fixation bracket and tie wraps
- seal foam tape

On this bracket one can fix the cables as well with ENSTO strength member fixation devices (separate item FIST-SB/MB-STRBR-01) and with hose clamps with an 8mm band.

BUDI-M-SEAL-6x15

Wrap around cable seal for 6 cables up to 15mm diameter including:

- cable fixation bracket and tie wraps
- seal foam tape

On this bracket one can fix the cables as well with ENSTO strength member fixation devices (separate item FIST-SB/MB-STRBR-01) and with hose clamps with an 8mm band.

BUDI-M-SEAL-3x20

Wrap around cable seal for 3 cables up to 20mm diameter and cable seal for looped cable installation (for both BUDI-M-SP and BUDI-M-T) including:

- cable fixation bracket, hose clamps and strength member fixation plates
- seal foam tape

BUDI-M-SEAL-24x5

Push Through cable seal for 24 cables up to 5mm diameter including:

- cable fixation brackets and tie wraps
- individual cable fixation

BUDI-M-SEAL-24x7

Push Through cable seal for 24 cables up to 7mm diameter including:

- cable fixation brackets and tie wraps
- cables are attached in groups of 4 cables

BUDI-M-PTS-48x3

Wrap around pigtail seal for 48 pigtails with a diameter up to 3.5mm (for indoor use)

- no cable fixation

BUDI-M-SEAL-6x15-MINI-B01

Seal + component to clip around the TE Mini-Breakout cable.

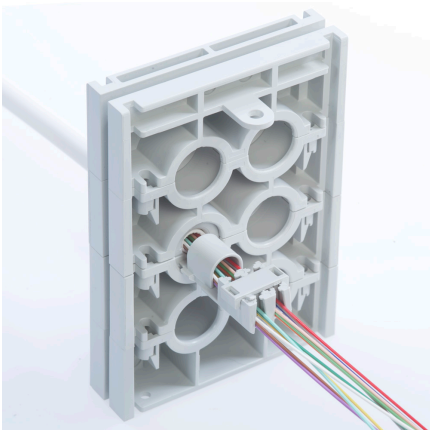

3.1.3 Shared BUDI-S and BUDI-M

BUDI-CBL-FIX1-GLD

This bracket allows you to fix cables in the BUDI-S and BUDI-M in combination with glands as FIST-GB-GLD-...

On this bracket one can fix the cables as well with ENSTO strength member fixation devices (separate item FIST-SB/MB-STRBR-01) and with hose clamps with an 8mm band.

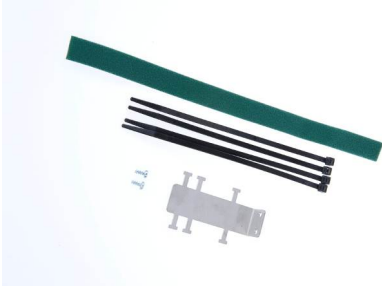

BUDI-S/M-INLINE-SEAL

Rubber seal allowing cable feed through from top ports.



3.2 Glands



Heat-shrink gland: FIST-GB-DRCHS-01

Drop cable heat-shrink seal kit for a single cable in a round port.

Cable range: diameter 8 – 21 mm

Hole size PG29



Pigtail seal – 24 pigtails: FIST-GB-PTS24-01

Wraparound pigtail seal seal 1 up to 24 single fiber pigtails

Cable range: diameter 0 - 3.0 mm.

Hole size: PG29

FIST-GB-PTS24-FLEXCLIP-10 (= 10pc)

Kit with wall mountable clips (including plugs and screws) to hold the wraparound flexible tube

Pigtail seal – 6 pigtails: FIST-GB-PTS6X4-PG21-01 (=1 pc)

Wraparound pigtail seal to seal 1 up to 6 single fiber pigtails

Cable range: diameter 0 – 4.0 mm.

Hole size: PG21

FIST-GB-PTS24-FLEXWRAP-01

Kit with 2 half shells to hold the flexible wraparound protection tubing on the pigtail seal FIST-GB-PTS24-01

FIST-WAFLEX-23-50 (50 m)

FIST-WAFLEX-23-10 (10 m)

Dual wall, flexible wraparound tube (dia. approx. 25mm) to enter in a FIST-GB-PTS24-FLEXWRAP-01 (see above).



Pigtail seal – 4 pigtails: FIST-GB-GLD16-PT4 (= 10 pcs)

Wraparound pigtail seal to seal 1 up to 4 single fiber pigtails

Cable range: diameter: 0 – 2.4 mm.

Hole size: PG16

Multiple cable seal: FIST-GB-GLD16-4X4MM (= 10pc)

Cable seal to seal up to 4 cables
Cable range: diameter 2.4 – 4mm.
Hole size: PG16

Multiple cable seal: FIST-GB-GLD21-4X6MM (= 10pc)

Cable seal to seal up to 4 cables
Cable range: diameter 4 - 6 mm.
Hole size: PG21

Multiple cable seal: FIST-GB-GLD21-4X7MM (= 10pc)

Cable seal to seal up to 4 cables
Cable range: diameter 5 -7 mm.
Hole size: PG21

Multiple cable seal: FIST-GB-GLD21-6X5MM (= 10pc)

Cable seal to seal up to 6 cables
Cable range: diameter 4 -5 mm.
Hole size: PG21

Multiple cable seal: FIST-GB-GLD21-8X4MM-10 (= 10pc)

Cable seal to seal up to 8 cables
Cable range: diameter 2.4 - 4 mm.
Hole size: PG21

Multiple cable seal: FIST-GB-GLD29-8X5.5MM (= 10pc)

Cable seal to seal up to 8 cables
Cable range: diameter 4 - 5.5 mm.
Hole size: PG29

Multiple cable seal: FIST-GB-GLD29-4X10MM (= 10pc)

Cable seal to seal up to 4 cables
Cable range: diameter 8 - 10 mm.
Hole size: PG29

**Single cable glands: FIST-GB-GLDXX-01**

Cable gland size ranges:
PG **16** - 6 to 14 mm
PG **21** - 9 to 18 mm
PG **29** - 15 to 26 mm
XX = cable gland size



**Flex tube gland: FIST-GB-GLD16-10-FLEX2 (= 10pc)**

Flex tube gland PG16 for tube with inside diameter 10 mm (FIST-GS-FLEX-10-50-S5027)
Hole size: PG16

BUDI-INLINE-1x18

BUDI-S and M top exit seal for indoor use

BUDI-2CONNECT-01

Component to connect two side mounted BUDI-S or M boxes to feed cables/fibers from one box into the other through the side port

**BUDI-MINI-BO-FIX01-D15**

Component to clip around the TE MINI-BREAKOUT cable to provide cable retention and PICO element fixation when inserted in a standard BUDI seal of D15mm. Box contains 100 clips.

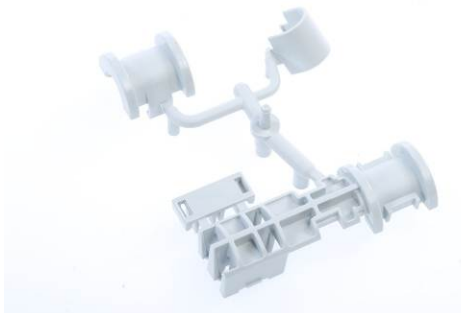
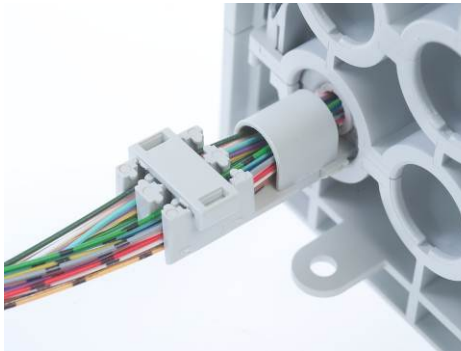

3.3 Other accessories

**FIST-GB-GRND-02**

Grounding feed-through kit (Internal and external grounding wire not included)

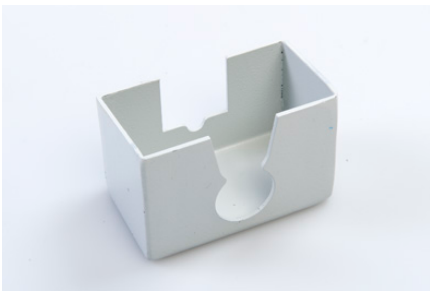
**BUDI-COVER-PROTECT-LOCK**

Universal cover to prevent opening BUDI boxes.

To be installed only in combination with the TE lock.

TE Connectivity products deliver a competitive advantage by meeting stringent demands for performance and reliability.

Innovative TE Connectivity components and systems are used in telecommunications, electronics, transportation, infrastructure and energy networks markets throughout the world.

Tyco Electronics Raychem bvba

Diestsesteenweg 692

B-3010 Kessel-Lo, Belgium

Tel.: 32-16-351 011

Fax: 32-16-351 697

www.te.com

www.telecomnetworks.com

TE (logo) and TE Connectivity are trademarks of the TE Connectivity group of companies and its licensors.

While TE Connectivity and its affiliates referenced herein have made every reasonable effort to ensure the accuracy of the information contained in this catalog, TE Connectivity cannot assure that this information is error free. For this reason, TE Connectivity does not make any representation or offer any guarantee that such information is accurate, correct, reliable or current. TE Connectivity reserves the right to make any adjustments to the information at any time. TE Connectivity expressly disclaims any implied warranty regarding the information contained herein, including, but not limited to, the implied warranties of merchantability or fitness for a particular purpose. TE Connectivity' only obligations are those stated in TE Connectivity' Standard Terms and Conditions of Sale. TE Connectivity will in no case be liable for any incidental, indirect or consequential damages arising from or in connection with, including, but not limited to, the sale, resale, use or misuse of its products. Users should rely on their own judgment to evaluate the suitability of a product for a certain purpose and test each product for its intended application.